



NeoGate TE200

User Manual

Version 17.17.0.43

Yeastar Information Technology Co. Ltd

Table of Contents

1. INTRODUCTION	4
1.1 Features	4
1.2 Hardware Specification	5
1.2.1 Exterior Appearance.....	5
2. SYSTEM SETUP.....	6
2.1 Connection Drawing	6
2.2 Connecting Ethernet Line	6
2.3 Supplying Power	6
3 ADMINISTRATOR LOGIN.....	7
4. STATUS.....	8
4.1 System Status.....	8
4.1.1 IP Trunk Status.....	8
4.1.2 E1/T1 Status.....	9
4.1.3 Network status.....	9
4.1.4 System info.....	10
4.2 Reports	10
4.2.1 Call logs.....	10
4.2.2 System logs	11
5. SYSTEM.....	11
5.1 Network Preferences	12
5.1.1 LAN Settings.....	12
5.1.2 WAN Settings	13
5.1.3 DDNS settings.....	14
5.1.4 Static Route.....	14
5.2 Firewall Settings	15
5.2.1 Firewall Rules.....	16
5.2.2 IP Blocklist.....	18
5.3 System Preferences	19
5.3.1 Password Settings.....	19
5.3.2 Date and Time.....	20
5.3.3 Backup and Restore.....	21
5.3.4 Reset and Reboot	22
5.3.5 Firmware Update.....	22
6. GATEWAY	23
6.1 Digital Trunk	23
6.2 VoIP Settings	27
6.2.1 VoIP trunk	27
6.2.2 SIP Settings.....	30

- 6.2.3 Trunk Group36
- 6.2.4 General Preferences37
- 6.3 Routes Settings 37
 - 6.3.1 Route List38
 - 6.3.2 Blocklist.....41
- 7. LOGOUT 41**
- 8. APPLICATION 42**

1. Introduction

NeoGate TE200- Bridge the gap between E1/T1/J1 and VoIP networks

NeoGate TE200 offers SMBs cost effective additions to legacy telephone systems to bring the true benefits of VoIP. TE200 is a dual-port VoIP E1/T1/J1 gateway (VoIP to E1/T1/J1, and E1/T1/J1 to VoIP). Each E1 trunk supports up to 30 concurrent calls. It's designed to bridge the gap between E1/T1/J1 and VoIP networks. Integrating TE200 into an existing network will allow inexpensive communication via SIP trunk. Also, it could connect VoIP systems with E1/T1/J1 service from legacy carriers.

1.1 Features

• Trunk Support
• Call Routing Rules
• Automatic appending and stripping of digits to dialed numbers
• Caller ID name and number support
• FAX support
• Blocklist
• Firewall
• DDNS Support
• Backup and Restore
• Easy to install (web based)
• G729 codec support

More info, please click: <http://www.yeastar.com/Products/NeoGate-TE200.asp>

1.2 Hardware Specification

1.2.1 Exterior Appearance

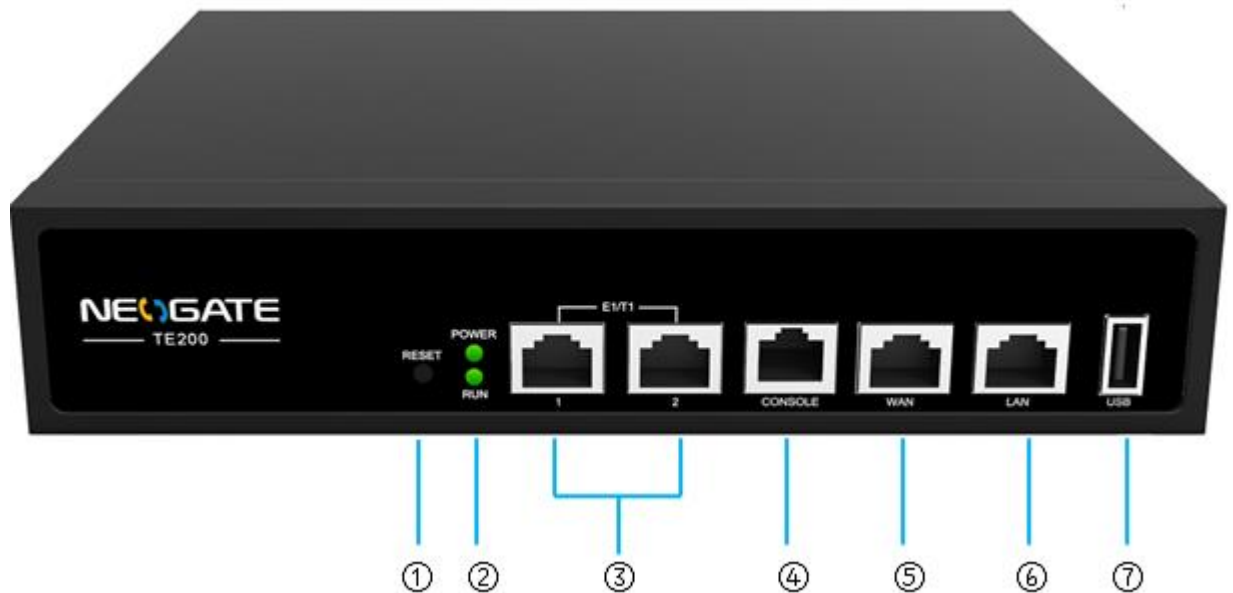

Figure 1-1

No.	Identifying
① Reset	The button to reset TE200 to factory defaults.
② Power	Green shining: Connected, correct function. Green flashing: Device error. No light: Disconnected, malfunction.
RUN	Green Light: Indicates the server system is in working order
③ E1/T1	E1/T1 interface
④ Console	Console interface(RJ45)
⑤ WAN	WAN port(10/100/1000 Mbps)
⑥ LAN	LAN port(10/100/1000 Mbps)
⑦ USB	USB 2.0 interface

2. System Setup

2.1 Connection Drawing

2.2 Connecting Ethernet Line

TE200 provides two 10/100/1000 Mbps Ethernet ports with RJ45 interface and LED indicator. Plug Ethernet line into TE200's Ethernet port, and then connect the other end of the Ethernet line with a hub, switch, router, LAN or WAN. Once connected, check the status of the LED indicator. A yellow LED indicates the port is in the connection process, and a green LED indicates the port is properly connected.

2.3 Supplying Power

Please follow the steps below to connect the TE200 unit to a power outlet:

1. Connect the small end of the power cable to the power input port on the TE200 back panel, and plug the other end of the cable into a 100V~240V AC power outlet.
2. Check the Power LED on the front panel. A solid green LED indicates that power is being supplied correctly.

3 Administrator Login

From your web browser, input the IP address of the NeoGate TE200.

If this is the first time you are configuring TE200, please use the default settings below (your PC should be in the same local network with TE200):

IP Address: <http://192.168.5.150>

Username: **admin**

Password: **password**

In this example, TE200's IP address is 192.168.7.120.

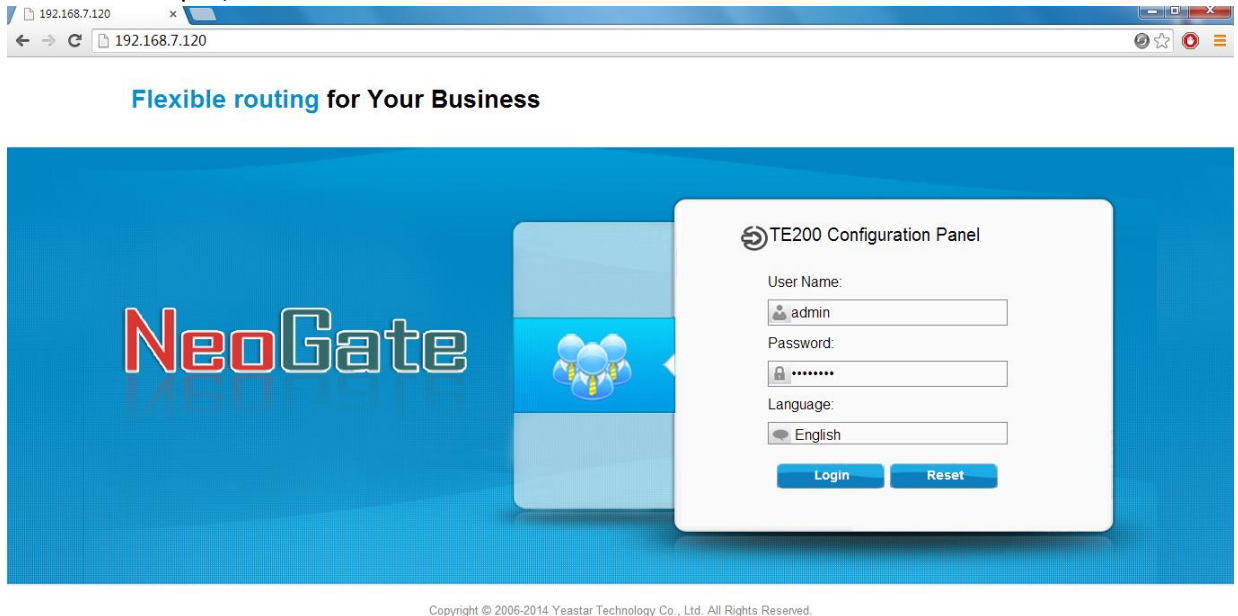

Figure 3-1

This is the welcome page of TE200 after login successfully.

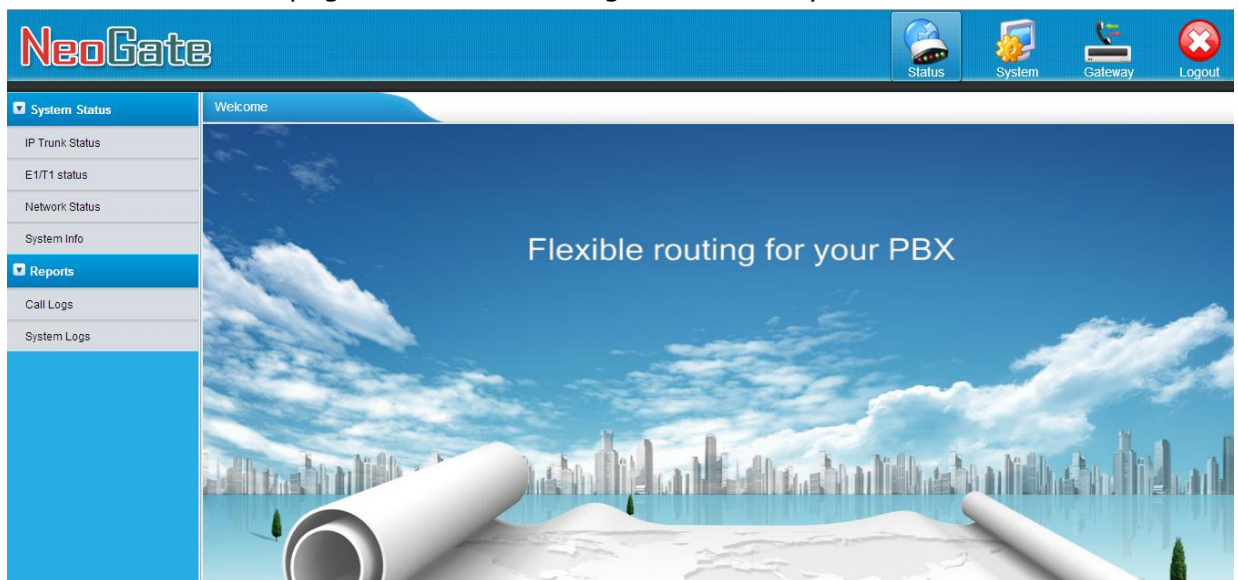



Figure 3-2

4. Status



Click  to start to check the status of TE200, including the system's status and the detailed reports

4.1 System Status

In this page, we can check the status of the system, including IP trunk status, E1/T1 status, network status and system information.

4.1.1 IP Trunk Status

Status	Signal	Trunk Name	Type	User Name	Hostname/IP	Reachability
Failed		101udp167	SIP	101	192.168.4.167	UNREACHABLE
OK (1 ms)		157sps	SP-SIP		192.168.5.157	OK (1 ms)
OK (1 ms)		158sps	SP-SIP		192.168.5.158	OK (1 ms)
OK (1 ms)		159sps	SP-SIP		192.168.5.159	OK (1 ms)
OK (1 ms)		192.168.4.65	SP-SIP		192.168.4.65	OK (1 ms)

Status	Account	Type
Unregistered	20001	SIP
Unregistered	20002	SIP

Figure 4-1

Trunks:

VoIP Trunk:

Status	Comment
Unregistered	Trunk registration failed.
Registered	Successful registration, trunk is ready for use.
Request Sent	Registering.
Waiting	Waiting for authentication.

Service Provider:

Status	Comment
OK	Successful registration, trunk is ready for use.
Unreachable	The trunk is unreachable.
Failed	Trunk registration failed.

4.1.2 E1/T1 Status

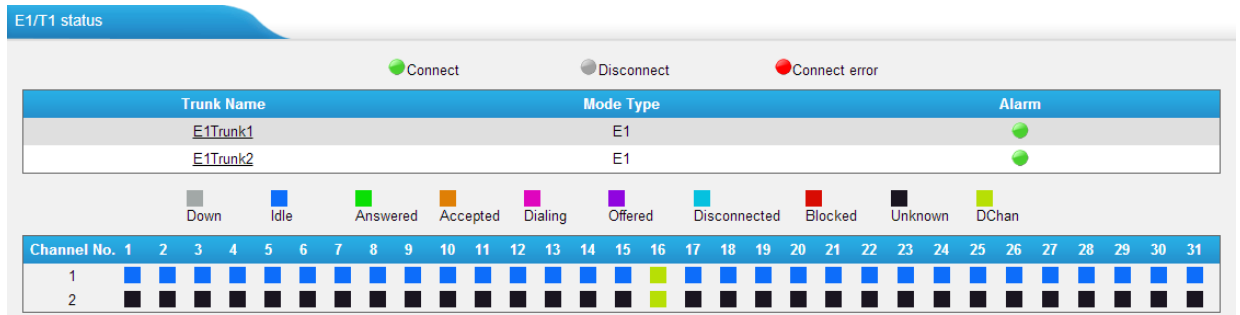

Figure 4-2

E1 Trunk

Status	Comment
	Connected successfully; data stream on the trunk is normal; but the trunk may not work if there is something wrong with the E1 trunk communication protocol.
	E1 line has been connected to the port; PRI is in corresponding or can't communicate.
	The port doesn't have E1 line connected.

Status of each channel of the E1 trunk:

Status	Comment
Down	The Channel is not connected.
Idle	The channel is idle, ready for use.
Answered	The channel is busy in a call.
Accepted	The channel has accepted the call, but the phone does not accept the call, i.e. the phone is ringing.
Dialing	The channel is dialing out.
Offered	The channel is accepting an incoming call.
Disconnected	The channel is requesting to hang up, but the line hasn't be released by the other end.
Blocked	At least one end is being blocked on the channel.
Unknown	The channel is being used in a non-call way, or status unknown.
DChan	D channel, the control and signaling information is being carried.

4.1.3 Network status

In this page, the IP address of LAN and WAN port will appear with their status.

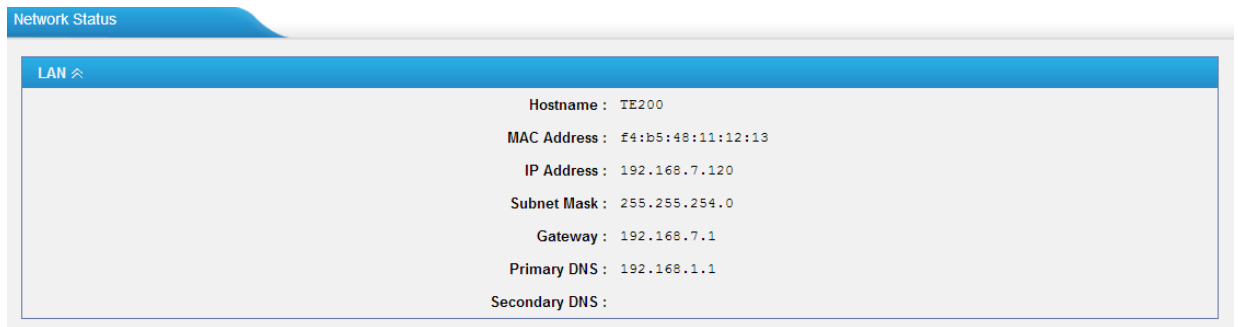

Figure 4-3

4.1.4 System info

In this page, we can check the hardware/firmware version, or the disk usage of TE200.

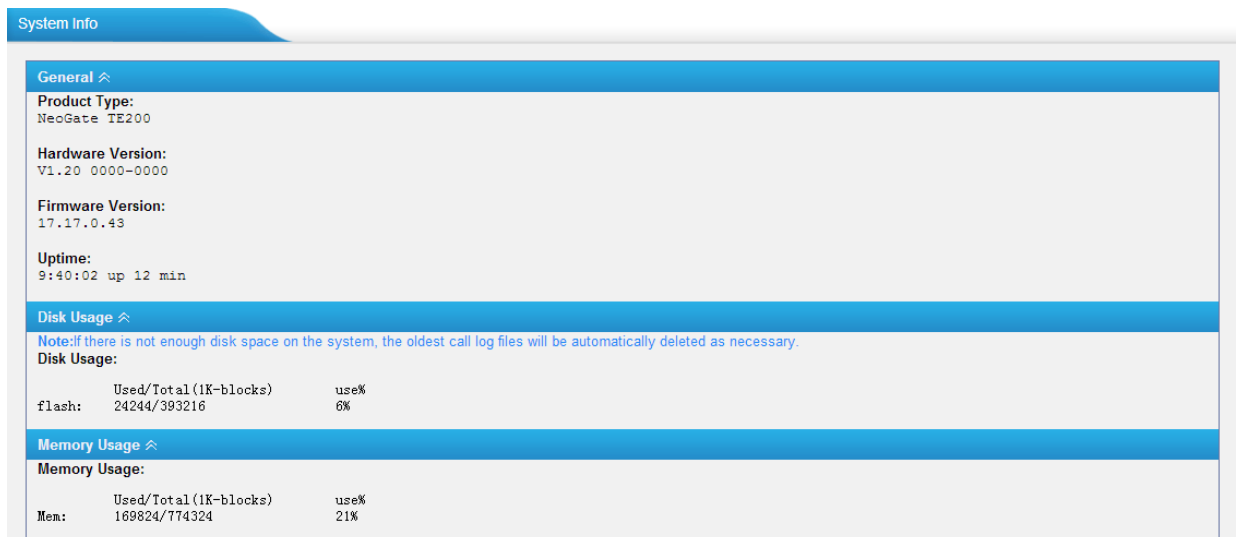

Figure 4-4

4.2 Reports

In this page, we can check the call detailed log and system log, which is used to debug the problem we meet.

4.2.1 Call logs

The call log captures all call details, including call time, caller number, callee number, call type, call duration, etc. An administrator can search and filter call data by filter the call logs by call date, caller/callee, trunk, duration, billing duration, status, or communication type.

Call Logs

Search Condition
 Start Date: 26 Feb 2013 End Date: 26 Feb 2013 Caller/Callee: Trunk: All
 Duration: Billing Duration: Status: All Communication Type: All Start Searching

Download the records Delete the records Total: 5 Show: 1-5 View: 25

Time	Caller	Callee	Source Trunk	Destination Trunk	Duration	Billing Duration	Status	Communication Type	Pin User
2013-02-26 05:46:23	503	501	Yeastar	E1Trunk1	6	4	ANSWERED	Outbound	X
2013-02-26 05:46:19	503	501	Yeastar	E1Trunk1	3	2	ANSWERED	Outbound	X
2013-02-26 05:46:13	503	501	Yeastar	E1Trunk1	5	3	ANSWERED	Outbound	X
2013-02-26 05:46:06	503	501	Yeastar	E1Trunk1	6	2	ANSWERED	Outbound	X
2013-02-26 05:45:51	503	501	Yeastar	E1Trunk1	8	4	ANSWERED	Outbound	X

<<Prev Next>> Page: 1 / 1 Goto

Figure 4-5

4.2.2 System logs

You can download and delete the system logs of TE200.

System Logs

Download The Selected Logs Delete The Selected Logs

Name	Type
web.log	Web

Options

Enable Hardware Log
 Enable Normal Log
 Enable Web Log
 Enable Debug Log

Save Cancel

Figure 4-6

5. System



Click  to access. In this page, we can configure the network settings, firewall rules and some system preferences.

5.1 Network Preferences

5.1.1 LAN Settings

The screenshot shows the 'LAN Settings' configuration page. The settings are as follows:

Setting	Value
DHCP	No
Enable SSH	Yes
Port	22
Hostname	TE200
IP Address	192.168.7.120
Subnet Mask	255.255.254.0
Gateway	192.168.7.1
Primary DNS	192.168.1.1
Secondary DNS	
IP Address2	
Subnet Mask2	

Figure 5-1

•DHCP

If this option is set as yes, TE200 will act as DHCP client to get an available IP address from your local network. Not recommended or you cannot access TE200 without the right IP address.

•Enable SSH

This is the advanced way to access the device, you can use the putty software to access the device. In the SSH access, you can do more advance setting and debug. It's disabled by default.

•**Port**: the default is 8022; you can change it to another one

•Hostname

Set the host name for TE200.

•IP Address

Set the IP Address for TE200.

It is recommended to configure a static IP address for TE200

•Subnet Mask

Set the subnet mask for TE200.

•Gateway

Set the gateway for TE200.

•Primary DNS

Set the primary DNS for TE200.

•Secondary DNS

Set the secondary DNS for TE200.

•IP Address2

Set the second IP Address for TE200.

•Subnet Mask2

Set the second subnet mask for TE200.

5.1.2 WAN Settings

Figure 5-2

3 connection types are supported: DHCP (obtain an IP automatically), PPPoE, Static IP Address.

Note:

1. WAN port is disabled by default.
2. WAN port cannot be used as a router to route the internet packages from WAN port to LAN port.

•DHCP

If your ISP says that you are connecting through DHCP or a dynamic IP address from your ISP, perform these steps:

Step1: Select **DHCP** as the WAN Connection Type.

Step2: Click **Save** button to save the settings.

Step3: Reboot the device.

Step4: Check the WAN's Status (Status→ Network Status).

•Static IP Address

If your ISP says that you are connecting through a static or fixed IP address from your ISP, perform these steps:

- Step1: Select **Static IP Address** as the WAN Connection Type.
 Step2: Enter the IP Address.
 Step3: Enter the Subnet Mask.
 Step4: Enter the Gateway Address.
 Step5: Enter the Primary DNS and Secondary DNS.
 Step6: Click the **Save** button to save the settings.
 Step7: Reboot the device.
 Step8: Check the WAN's Status (Status→ Network Status).

•PPPoE

If your DSL provider says that you are connecting through PPPoE or if you Normally enter a user name and password to access the Internet, perform these Steps:

- Step1: Select **PPPoE** as the WAN Connection Type.
 Step2: Enter the User Name.
 Step3: Enter the Password.
 Step4: Click the **Save** button to save the settings.
 Step5: Reboot the device.
 Step6: Check the WAN's Status (Status→ Network Status)

5.1.3 DDNS settings

DDNS (Dynamic DNS) is a method / protocol / network service that provides the capability for a networked device, such as a router or computer system using the Internet Protocol Suite, to notify a Domain Name System (DNS) name server to change, in real time, the active DNS configuration of its configured hostnames, addresses or other information.

DDNS Settings

DDNS Settings

Note: DDNS allows you to access your network using domain names instead of IP address. The service manages changing IP address and updates your domain information dynamically. You must sign up for service through dyndns.org, freedns.afraid.org, www.no-ip.com, www.zoneedit.com

DDNS is not running

Enable DDNS:

DDNS Server:

User Name:

Password:

Host Name:

Figure 5-3

5.1.4 Static Route

TE200 will have more than one internet connection in some situations but it has only one default gateway. You will need to set some Static Route for TE200 to

force it to go out through different gateway when access to different internet. The default gateway priority of TE200 from high to low is WAN port→LAN port.

Static Route Settings

Routing Table				
Destination	Subnet Mask	Gateway	Metric	Interface
192.168.6.0	255.255.254.0	0.0.0.0	0	LAN
0.0.0.0	0.0.0.0	192.168.7.1	0	LAN

Static Route Rules

Destination: Subnet Mask: Gateway: Metric: Interface: LAN

No Static Routes Defined

Figure 5-4

1) Route Table

The current route rules of TE200.

•Destination

The destination network to be accessed by TE200.

•Subnet Mask

Specify the destination network portion.

•Gateway

Define which gateway TE200 will go through when access to the destination network.

•Metric

The cost of a route is calculated by using what are called routing metric. Routing metrics are assigned to routes by routing protocols to provide measurable statistic which can be used to judge how useful (how low cost) a route is.

•Interface

Define which internet port to go through.

2) Static Route Rules

You can add new static route rules here.

5.2 Firewall Settings

Firewalls are used to prevent unauthorized Internet users from accessing private networks connected to the Internet, especially intranets. All messages entering or leaving the intranet pass through the firewall, which examines each

message and blocks those that do not meet the specified security criteria.

5.2.1 Firewall Rules

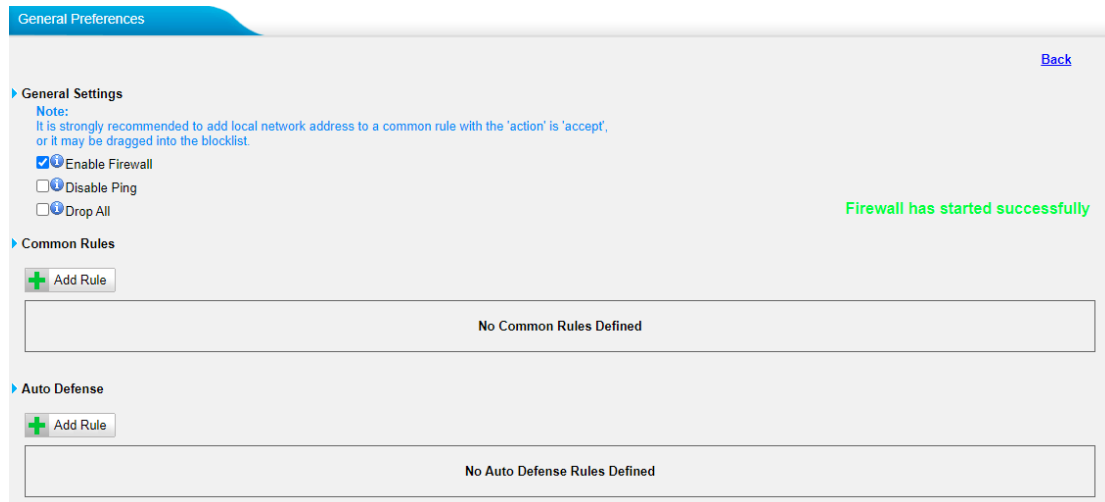

Figure 5-5

1) General Settings

•Enable Firewall

Enable the firewall to protect the device. You should reboot the device to make the firewall run successfully.

•Disable Ping

Enable this item; net ping from remote hosts will be dropped.

•Drop All

When you enable "Drop All" feature, system will drop all packets or connection from other hosts if there are no other rules defined. To avoid locking the devices, at least one "TCP" accept common rule must be created for port used for SSH access, port used for HTTP access and port used for CGI access.

2) Common Rules

There are no default rules inside; you can create them as required

Figure 5-6

•Name

A name for this rule, e.g. "HTTP".

•Description

Simple description for this rule. E.g. Accept the specific host to access the web interface for configuration.

•Protocol

The protocols for this rule.

•Port

Initial port should be on the left and end port should be on the right.
The end port must be equal to or greater than start port.

•IP

The IP address for this rule. The format of IP address is: IP/mask
E.g. 192.168.5.100/255.255.255.255 for IP 192.168.5.100
E.g. 216.207.245.47/255.255.255.255 for IP 216.207.245.47
E.g. 192.168.5.0/255.255.255.0 for IP from 192.168.5.0 to 192.168.5.255 .

•MAC Address

The format of MAC Address is XX:XX:XX:XX:XX:XX, X means 0~9 or A~F in hex, the A~F are not case sensitive.

Note: The MAC address of a remote device will be changed when data reach TE200. So filtering MAC address of remote devices will not work

•Action

Accept: Accept the access from remote hosts.
Drop: Drop the access from remote hosts.

Ignore: Ignore the access.

3) Auto Defense

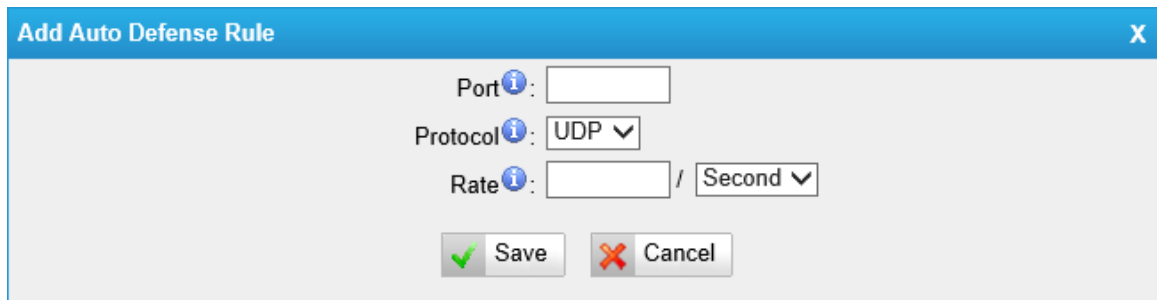

The screenshot shows a dialog box titled "Add Auto Defense Rule". It has three input fields: "Port" (empty), "Protocol" (set to "UDP"), and "Rate" (empty) followed by a unit dropdown set to "Second". There are "Save" and "Cancel" buttons at the bottom.

Figure 5-7

•Port

Auto defense port, e.g. 8022.

•Protocol

Auto defense protocol, TCP or UDP.

•Rate

The maximum packets or connections can be handled per unit time.

E.g. (Port: 8022 Protocol: TCP Rate: 10/minute) means maximum 10 TCP connections to port 8022 can be handled per minute, the eleventh connection will be refused directly.

5.2.2 IP Blocklist

You can set some packets accept speed rules here. When an IP address which hasn't been accepted in common rules sends packets faster than the allowed speed, it will be set as black IP address and blocked automatically.

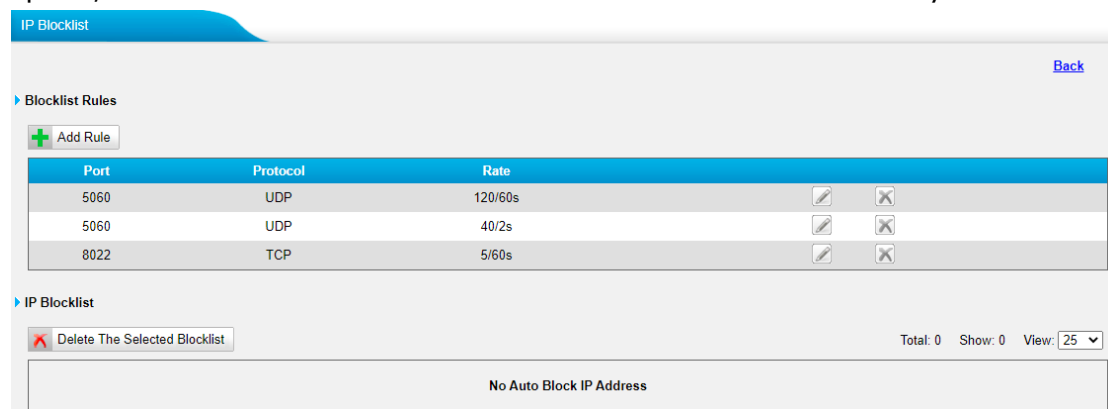

The screenshot shows the "IP Blocklist" configuration page. It has a "Back" button in the top right. Under "Blocklist Rules", there is an "Add Rule" button and a table with the following data:

Port	Protocol	Rate		
5060	UDP	120/60s		
5060	UDP	40/2s		
8022	TCP	5/60s		

Below the table is the "IP Blocklist" section, which has a "Delete The Selected Blocklist" button and a "Total: 0 Show: 0 View: 25" dropdown. The main content area is empty, displaying "No Auto Block IP Address".

Figure 5-8

1) Blocklist rules

We can add the rules for IP Blocklist rate as your demand.

Figure 5-9

•Port

Auto defense port

•Protocol

Auto defense protocol. TCP or UDP.

•IP Packets

Allowed IP packets number in the specific time interval.

•Time interval

The time interval to receive IP packets. For example, IP packets 90,time interval 60 means 90 IP packets are allowed in 60 seconds.

2) IP Blocklist

The blocked IP address will display here, you can edit or delete it as your wish.

5.3 System Preferences

5.3.1 Password Settings

We can change the password of account "admin" in this page, but you need to input the old password before input a new one.

Figure 5-10

●Enter Old Password

The default password of account "admin" is "password".

●Enter New Password

Input the new password

●Retype New Password

To change the password, enter the new password and click update. The system will then prompt you re-login using your new password.

5.3.2 Date and Time

Set the date and time for TE200.

Figure 5-11

•Time Zone

You can choose your time zone here.

•Daylight Saving Time

Set the mode to Automatic or disabled.

•Automatically Synchronize With an Internet Time Server

Input the NTP server so that TE200 will update the time automatically.

•Set Date & Time Manually

You can set the time to your local right time manually here.

5.3.3 Backup and Restore

We can backup up the configurations before reset TE200 to factory defaults, and then restore it using this package.

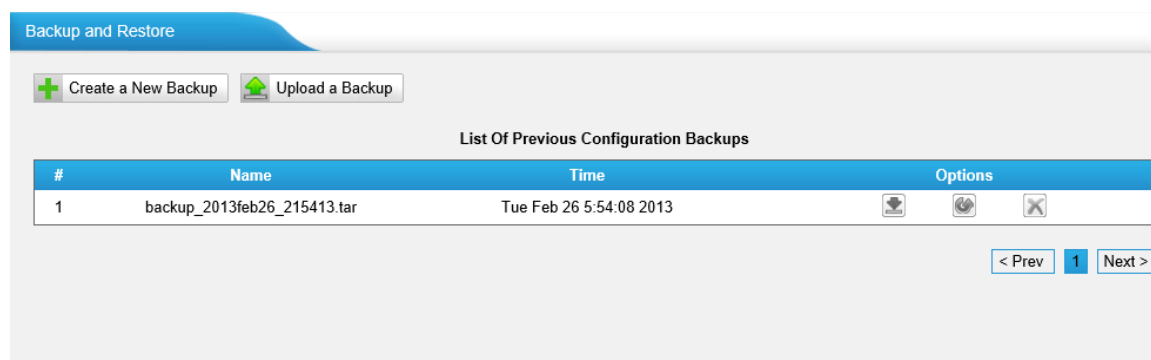

Figure 5-12

To restore the backup package, please click "Upload a Backup", then upload it from your local PC.

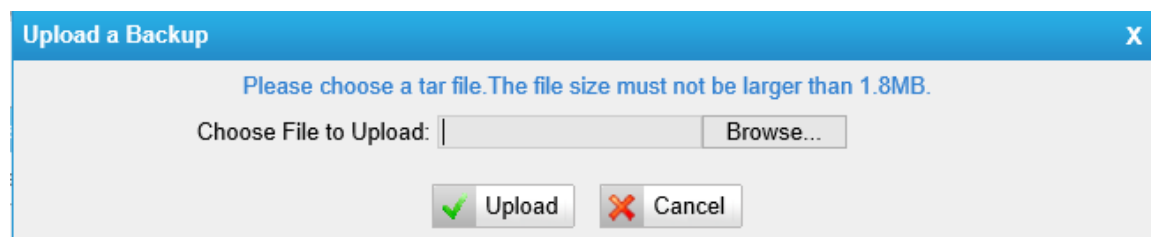

Figure 5-13

Note:

1. Please make sure the file size must not be larger than 1.8MB.
2. When you have updated the firmware version, it's not recommended to restore using old package.

5.3.4 Reset and Reboot

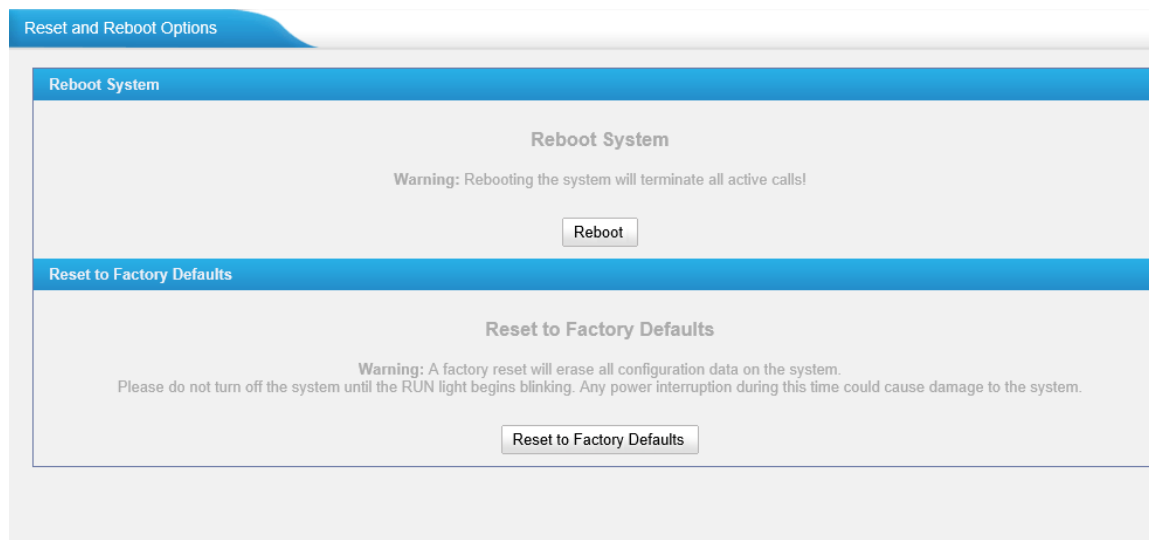

Figure 5-14

•Reboot System

Warning: Rebooting the system will terminate all active calls!

•Reset to Factory Defaults

Warning: A factory reset will erase all configuration data on the system. Please do not turn off the system until the RUN light begins blinking. Any power interruption during this time could cause damage to the system.

5.3.5 Firmware Update

Upgrading of the firmware is possible through the Administrator web interface using a TFTP Server or an HTTP URL.

Enter your TFTP Server IP address and firmware file location, then click start to update the firmware

Note:

1. If enabled "Reset configuration to Factory Defaults", the system will restore to factory default settings.
2. When updating the firmware, please don't turn off the power. Or the system will get damaged.
3. For more information about the steps to update the firmware, please refer to this [link:](http://www.yeostar.com/download/NeoGate_TE200_FirmwareUpgrade_en.pdf)
http://www.yeostar.com/download/NeoGate_TE200_FirmwareUpgrade_en.pdf

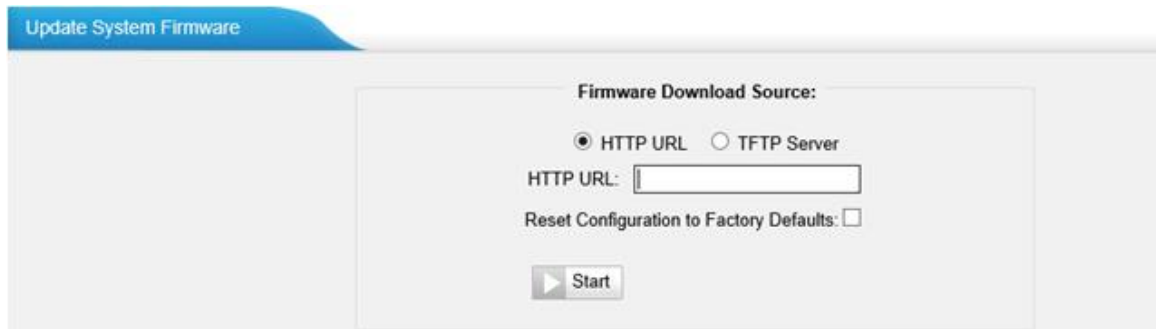

Figure 5-15

6. Gateway

6.1 Digital Trunk

On this page we can configure the details of E1 trunk, before configure anything, please make sure the cable is fine, and you have got enough information from the ISDN provider.

Trunk Name	Mode Type	Signaling	Echo Cancellation	
E1Trunk1	E1	PRI	On	
E1Trunk2	E1	MFC/R2	On	

Figure 6-1

On the digital trunk page, click "Edit" on the selected trunk and modify its properties in the popup window:

Edit Digital Trunk E1Trunk1
X

General Settings

Mode Type: <input type="text" value="E1"/>	Signaling: <input type="text" value="PRI"/>
Linecoding: <input type="text" value="HDB3"/>	Codec: <input type="text" value="alaw"/>
Echo Cancellation: <input type="text" value="On"/>	Framing: <input type="text" value="Disable CRC"/>

PRI Basic option

Switch Type: <input type="text" value="national"/>	Switch Side: <input type="text" value="User"/>
--	--

PRI Advanced option

Enable Facility: <input type="text" value="Enabled"/>	Overlap Dial: <input type="text" value="Disable"/>
Reset Interval: <input type="text" value="3600"/> s	PRI Indication: <input type="text" value="Inband"/>
Remote Dialplan: <input type="text" value="unknown"/>	Remote Number Type: <input type="text" value="unknown"/>
Location Dialplan: <input type="text" value="unknown"/>	Location Number Type: <input type="text" value="unknown"/>
Screen Indicator: <input type="text" value="User-provider"/>	Presentation Indicator: <input type="text" value="allowed"/>
Nsf: <input type="text" value="none"/>	

Caller ID Prefix

International Prefix: <input type="text"/>	National Prefix: <input type="text"/>
Local Prefix: <input type="text"/>	Private Prefix: <input type="text"/>
Unknown Prefix: <input type="text"/>	

DOD Settings

Global DOD:

DOD:
Associated Account:

Figure 6-2

1) General Settings

•Mode Type

E1 / T1 / J1

•Signaling

PRI, MFC/R2, SS7

•Linecoding

HDB3, AMI, B8ZS

•Codec

Default: A-Law, U-Law.

•Echo Cancellation

This disables or enables echo cancellation, it is recommended not to turn this off.

.Framing

CRC Verification.

2) PRI Basic Option**•Switch Type**

national: National ISDN type2 (common in the US)

ni1: National ISDN type 1

dms100: Nortel DMS100

4ess: AT&T 4ESS

5ess: Lucent 5ESS

euroisdn: EuroISDN

qsig: Minimalistic protocol to build a "network" with two or more PBX of different vendors!

.Switch Side

User, Network

3) PRI Advanced Option**.Enable Facility**

To enable transmission of facility-based ISDN supplementary services (such as caller name from CPE over facility).

•Over Lap Dial

Define whether TE200 can dial this switch using overlap digits. If you need Direct Dial-in (DDI; in German "Durchwahl") you should change this to yes, then TE200 will wait after the last digit it receives.

•Reset interval

Set the time in seconds between restart of unused channels. Some PBXs don't like channel restarts. so set the interval to a very long interval e.g. 100000000 or "never" to disable entirely. If you are in Israel, the following is important: As Bezeq in Israel doesn't like the B-Channel resets happening on the lines, it is best to set the reset interval to 'never' when installing a box in Israel. Our past experience also shows that this parameter may also cause issues on local switches in the UK and China.

•PRI Indication

Tells how Device should indicate Busy () and Congestion() to the switch/user.

Accepted values are:

inband: Device plays indication tones without answering; not available on all PRI/BRI subscription lines .

outofband: Device disconnects with busy/congestion information code so the switch will play the indication tones to the caller. Busy() will now do same as setting PRI_CAUSE=17 and Hangup().

•Remote Dialplan

Called number type

•Remote Number Type

Called number identification

•Location Dialplan

Calling number type

•Location Number Type

Calling number identification

Screen Indicator(SI)

The SI provides information on the source and the quality of the provided information.

•Presentation Indicator(PI)

The PI provides instructions on whether or not the provided calling line identity is allowed to be presented, or indicates that the number is not available.

•Nsf

Used with AT&T PRIs. If outbound calls are being rejected due to "Mandatory information element missing" and the missing IE is 0x20, then you need this setting

4) Caller ID Prefix

•International Prefix

When there are international calls coming in via this BRI trunk, the International Prefix you have set here will be added before the CID. So you can know this is an international call before you answer it.

•National Prefix

When there are national calls coming in via this BRI trunk, the National Prefix you have set here will be added before the CID. So you can know this is a national call before you answer it.

•Local Prefix

When there are Local calls coming in via this BRI trunk, the Local Prefix you have set here will be added before the CID. So you can know this is a local call before you answer it.

•Private Prefix

When there are Private calls coming in via this BRI trunk, the Private Prefix you have set here will be added before the CID. So you can know this is a Private call before you answer it.

•Unknown Prefix

When there are calls with unknown number coming via this BRI trunk, the Unknown Prefix you set here will be shown as the caller ID.

5) DOD Settings

DOD (Direct Outward Dialing) means the caller ID displayed when dialing out, before configure this, please make sure the provider supports this feature

•Global DOD

Global direct outward dialing number.

6.2 VoIP Settings

In this page, we can create VoIP trunk and the trunk group for routing, and some SIP settings and the general preferences.

6.2.1 VoIP trunk

There are 3 types of trunks listed in this page, Account, Trunk and Service Provider.

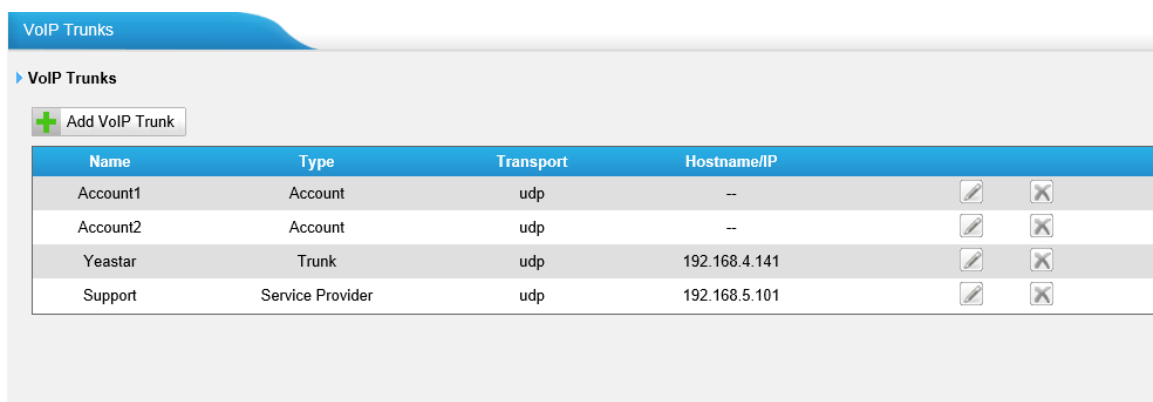

Name	Type	Transport	Hostname/IP		
Account1	Account	udp	--		
Account2	Account	udp	--		
Yeastar	Trunk	udp	192.168.4.141		
Support	Service Provider	udp	192.168.5.101		

Figure 6-3

1) Account

Its an SIP account created in TE200 so that the other devices can register SIP trunk at their side using these information.

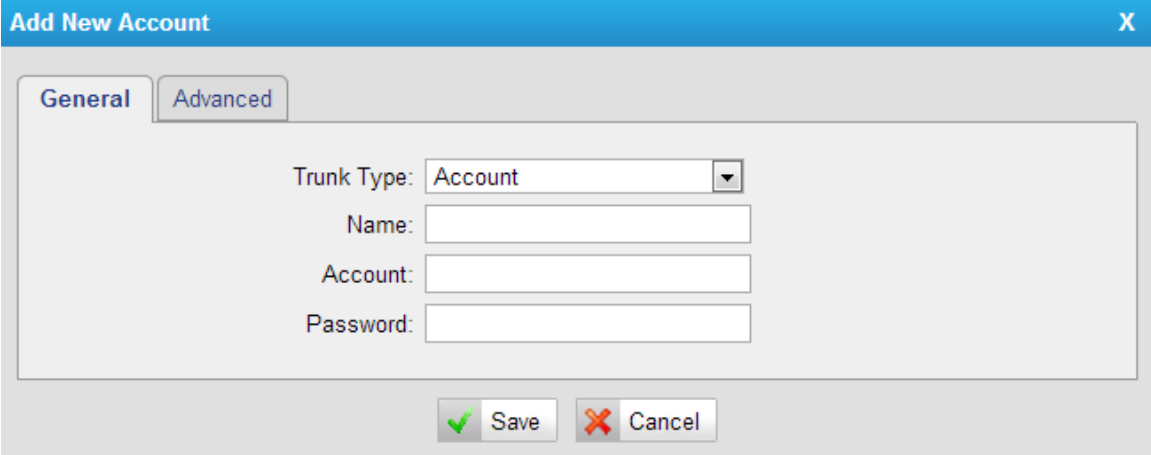

Figure 6-4

•Trunk type:

Choose the type of trunk, for example "Account".

•Name:

Input the name of this account trunk.

•Account:

Design the account for other device to register to.

•Password:

Design the password for other device to register to.

•Caller ID:

Design the caller ID to dial out via this account.

2) Trunk

It's a SIP trunk configured in TE200 to register to the SIP provider, please make sure this trunk is working fine in advance with provider before configuring TE200.

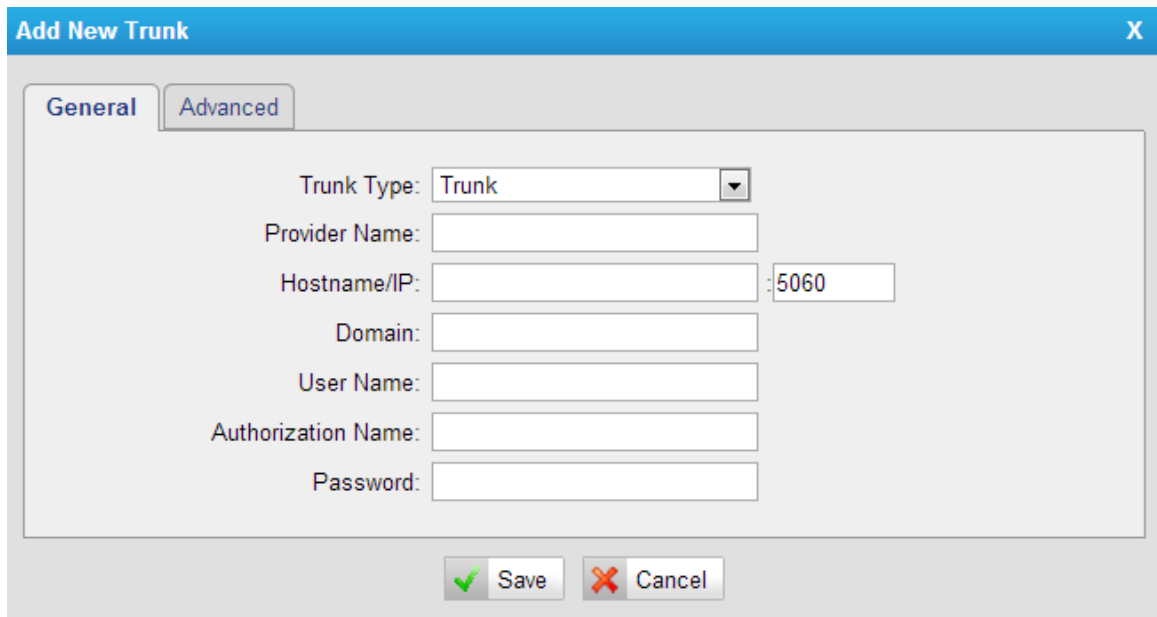

Figure 6-5

•Provider name:

A unique label to help you identify this trunk when listed in outbound rules, incoming rules etc. E.g. "yeastar".

•Hostname/IP:

Service provider's hostname or IP address. 5060 is the standard port number used by SIP protocol. Don't change this part if it is not required.

•Domain:

VoIP provider's server domain name.

•Username

User name of sip account, which is used for sip trunk registration.

•Authorization name

Used for SIP authentication. Leave this blank if not required.

•Password

Password of SIP account.

3) Service provider

This is service provider trunk (peer to peer mode), which authorized using IP address only. If you have got a trunk with IP address only, please choose this type.

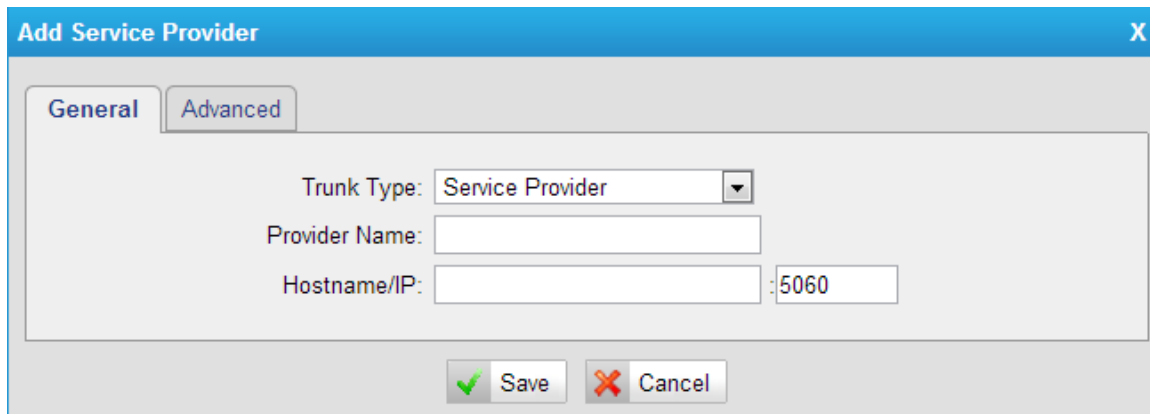

Figure 6-6

•Trunk type:

Choose "Service Provider" type.

•Provider Name

A unique label would help to you identify this trunk. E.g. "Provider2".

•Hostname/IP

Service provider’s hostname or IP address.

Note: 5060 is the standard port number used by SIP protocol. Don't change this part if it is not required.

6.2.2 SIP Settings

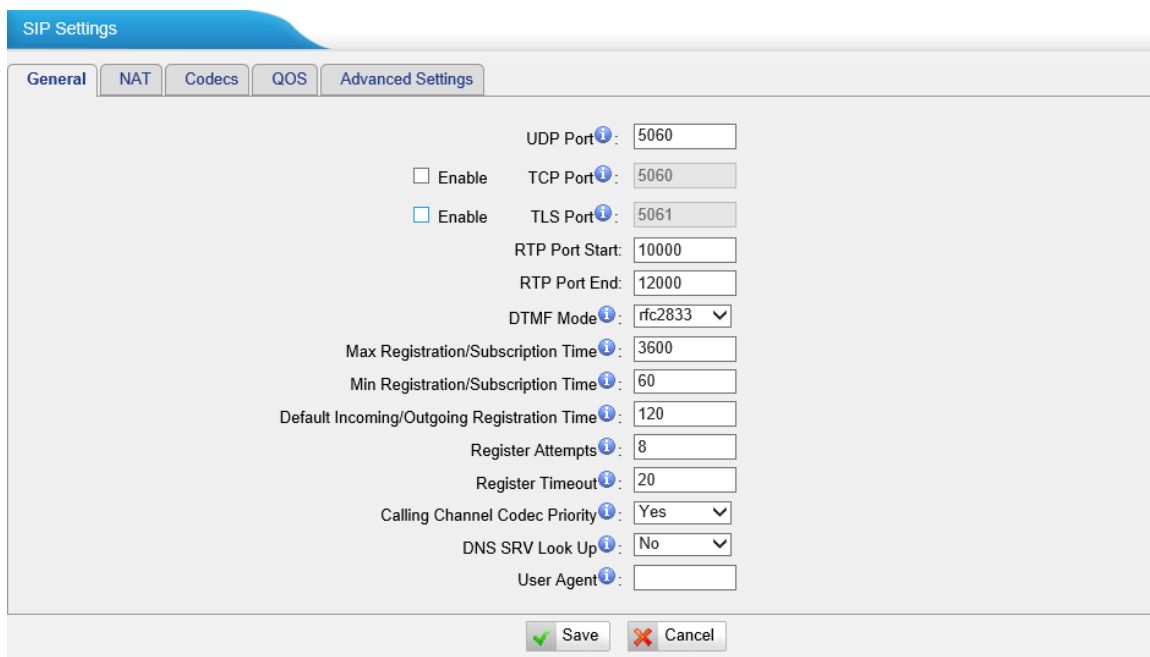

Figure 6-7

1) General

•UDP Port

Port use for sip registrations, Default is 5060.

•TCP Port

Port use for sip registrations, Default is 5060.

•TLS Port

Port use for sip registrations, Default is 5061.

•RTP Port Start

Beginning of RTP port range.

•RTP Port End

End of RTP port range.

•DTMF Mode

Set default mode for sending DTMF. Default setting: rfc2833.

•Max Registration/Subscription Time

Maximum duration (in seconds) of a SIP registration. Default is 3600 seconds.

•Min Registration/Subscription Time

Minimum duration (in seconds) of a SIP registration. Default is 60seconds.

•Default Incoming/Outgoing Registration Time

Default Incoming/Outgoing Registration Time: Default duration (in seconds) of incoming/outgoing registration.

•Register Attempts

The number of SIP REGISTER messages to send to a SIP Registrar before giving up. Default is 8 times.

•Register Timeout

Number of seconds to wait for a response from a SIP Registrar before timed out . Default is 20 seconds.

•Calling Channel Codec Priority

Once enabled, when dialing out via SIP/SPS trunks, the codec of calling channel will be selected in preference. If not, TE200 will follow the priority in your SIP/SPS trunks.

•DNS SRV Look Up

Please enable this option when your SIP trunk contains more than one IP address.

•User Agent

To change the user agent parameter of asterisk, you should change it if needed.

2) NAT

Note: Configuration of this section is only required when using remote registry.

The screenshot shows the 'SIP Settings' window with the 'NAT' tab selected. The window contains the following fields and controls:

- Note:** Configuration of this section is only required when you use remote extensions.
- Enable STUN:**
- STUN Address:**
- STUN Port:**
- External IP Address:**
- External Host:**
- External Refresh Interval:**
- Local Network Identification:**
- NAT Mode:**
- Allow RTP Re-invite:**
- Buttons:** Save (with green checkmark icon) and Cancel (with red X icon).

Figure 6-8

•Enable STUN

STUN (Simple Traversal of UDP through NATs) is a protocol for assisting devices behind a NAT firewall or router with their packet routing.

•STUN Address

The STUN server allows clients to find out their public address, the type of NAT they are behind and the internet side port associated by the NAT with a particular local port. This information is used to set up UDP communication between the client and the VOIP provider and so establish a call.

•External IP Address

The IP address that will be associated with outbound SIP messages if the system is in a NAT environment.

•External Host

Alternatively you can specify an external host, and the system will perform DNS queries periodically.

This setting is only required when your public IP address is not static. It is recommended that a static public IP address be used with this system. Please contact your ISP for more information.

-External Refresh Interval

If an external host has been supplied, you may specify how often the system will perform a DNS query on this host. This value is specified in seconds.

-Local Network Identification

Used to identify the local network using a network number/subnet mask pair when the system is behind a NAT or firewall.

Some examples of this are as follows:

"192.168.0.0/255.255.0.0": All RFC 1918 addresses are local networks;

"10.0.0.0/255.0.0.0": Also RFC1918;

"172.16.0.0/12": Another RFC1918 with CIDR notation;

"169.254.0.0/255.255.0.0": Zero conf local network.

Please refer to RFC1918 for more information.

-NAT Mode

Global NAT configuration for the system. The options for this setting are as follows:

Yes = Use NAT. Ignore address information in the SIP/SDP headers and reply to the sender's IP address/port.

No = Use NAT mode only according to RFC3581.

Never = Never attempt NAT mode or RFC3581 support.

Route = Use NAT but do not include report in headers.

-Allow RTP Reinvite

By default, the system will route media streams from SIP endpoints through itself. Enabling this option causes the system to attempt to negotiate the endpoints to route packets to each other directly, bypassing the system. It is not always possible for the system to negotiate endpoint-to-endpoint media routing.

3) Codecs

Figure 6-9

A codec is a compression or decompression algorithm that used in the transmission of voice packets over a network or the Internet.

u-law: A PSTN standard codec, used in North America, which provides very good voice quality and consumes 64kbit/s in each direction (receiving and transmitting) of a VoIP call.

a-law: A PSTN standard codec, used outside of North America, which provides very good voice quality and consumes 64kbit/s in each direction (receiving and transmitting) of a VoIP call.

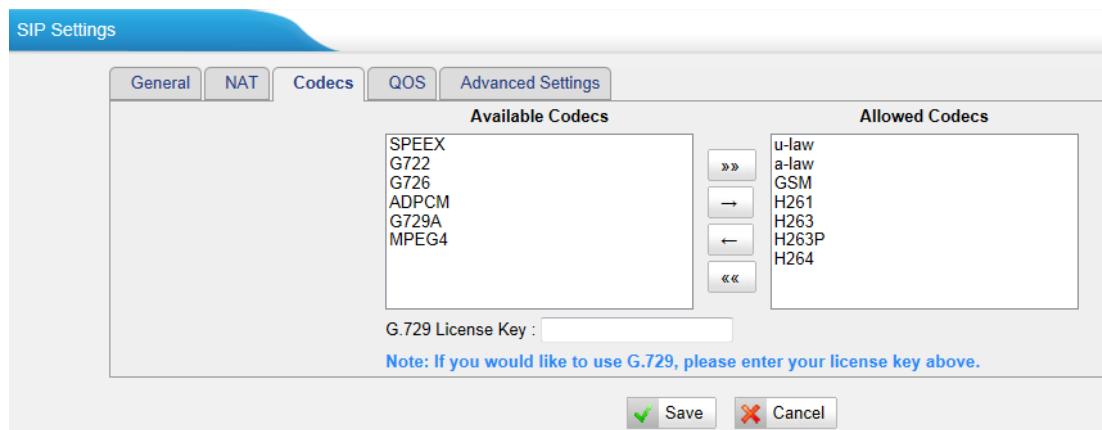
GSM: A wireless standard codec, used worldwide, that provides adequate voice quality and consumes 13.3kbit/s in each direction (receiving and transmitting) of a VoIP call. GSM is supported by many VoIP phones.

SPEEX: Speex is an Open Source/Free Software patent-free audio compression format designed for speech. The Speex Project aims to lower the barrier of entry for voice applications by providing a free alternative to expensive proprietary speech codecs. Moreover, Speex is well-adapted to Internet applications and provides useful features that are not present in most other codecs.

G.722:G.722 is a wideband speech coding algorithms which supports the bit rate of 64, 56 and 48kbps wideband. It's a broadband voice encoding of G series.

G.726: A PSTN codec, used worldwide, that provides good voice quality and consumes 32kbit/s in each direction (receiving and transmitting) of a VoIP call. G.726 is supported by some VoIP phones.

ADPCM, G.729A, H261, H263, H263p, H264,MPEG4.

Note: If you would like to use G.729, please enter your license.

4) QOS

The screenshot shows the 'SIP Settings' dialog box with the 'QOS' tab selected. The settings are as follows:

Setting	Value
Tos SIP	CS3
Tos Audio	EF
Cos SIP	3
Cos Audio	5

At the bottom of the dialog, there are two buttons: 'Save' (with a green checkmark icon) and 'Cancel' (with a red X icon).

Figure 6-10

QoS (Quality of Service) is a major issue in VOIP implementations. The issue is how to guarantee that packet traffic for a voice or other media connection will not be delayed or dropped due interference from other lower priority traffic. When the network capacity is insufficient, QoS could provide priority to users by setting the value.

5) Advanced Settings

The screenshot shows the 'SIP Settings' window with the 'Advanced Settings' tab selected. The settings are as follows:

- From Field: From
- To Field: INVITE
- 180 Ringing:
- Remote Party ID: send trust
- Allow Guest: No
- Pedantic: No
- Session-timers: Accept
- Session-expires: 1800 s
- Session-minse: 90 s
- Session-refresher: Uas

At the bottom of the window, there are 'Save' and 'Cancel' buttons.

Figure 6-11

•From Field

Where to get the caller ID in sip packet.

•To Field

Where to get the DID in sip packet.

•180 Ringing

It is set when the telecom provider needs. Usually it is not needed.

•Qualify

Send check alive packets to the sip provider.

•Remote Party ID

Whether send Remote-Party-ID on SIP header. Default no.

•Allow Guest

Whether allow anonymous registration extension. Default: no.

This option is used to avoid some anonymous calls by hackers.

•Pedantic

Enable pedantic parameter. Default: no.

-Session -timers

Enable sesstion-timer mode, default: yes.

-Sesstion-expires

The max refresh interval.

-Sesstion-minse

The min refresh interval, which mustn't be less than 90s .

-Sesstion-refresher

Choose sesstion-refersher, the default is Uas.

6.2.3 Trunk Group

Trunk group is a new feature that allowed adding some trunks into a group, which we can use it in the "routing rules".

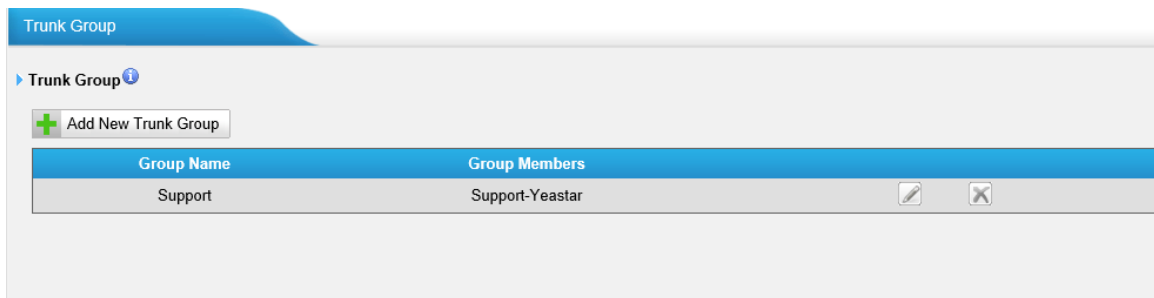

Figure 6-12

Click "Add New Trunk Group".

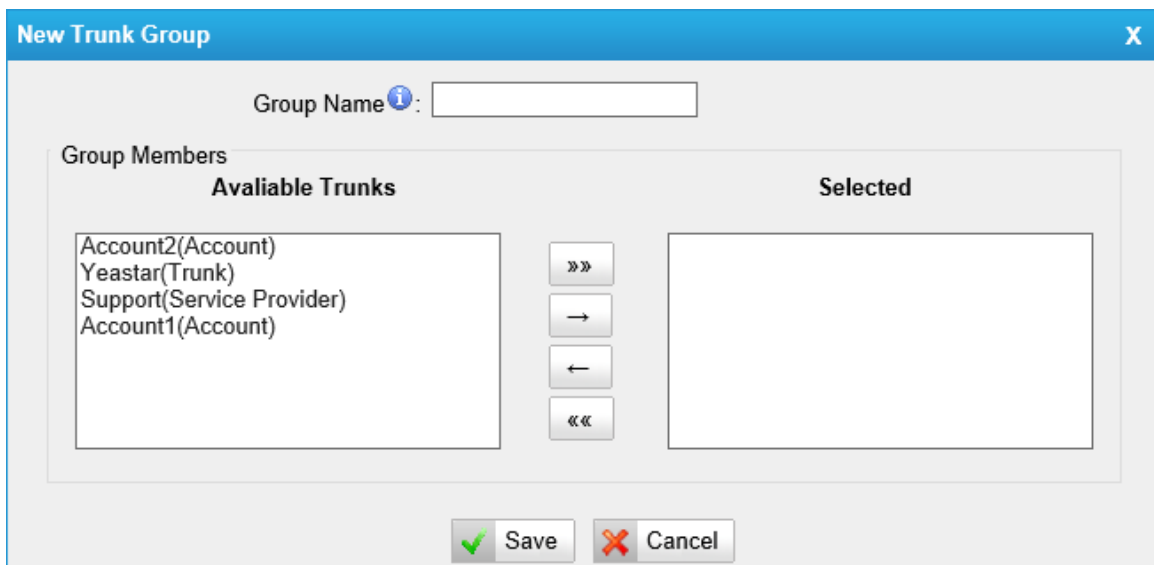

Figure 6-13

Group name

Input the name of this group.

Group members

All the SIP trunk you created will be listed here, please choose the appropriate trunk to the right side as a group.

6.2.4 General Preferences

This is the general preferences of TE200

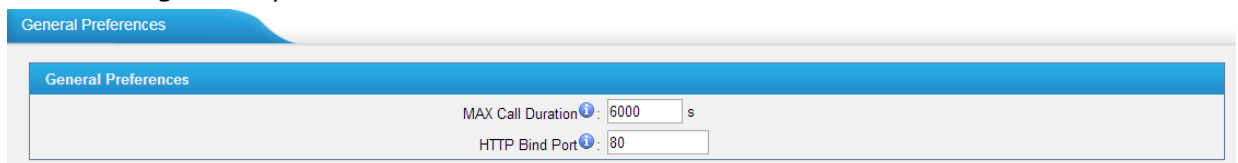

General Preferences

General Preferences

MAX Call Duration: 6000 s

HTTP Bind Port: 80

Figure 6-14

.MAX call duration

The absolute maximum amount of time permitted for a call. A setting of 0 disables the timeout. Default value is 6000s.

·HTTP bind port/Web Access Port

Port to use for HTTP sessions. Default: 80

Note: please reboot the system to take effect.

6.3 Routes Settings

There are two default routes to route the calls from E1 to SIP and SIP to E1. In this page, we can route the call from one trunk to another trunk or a trunk group.

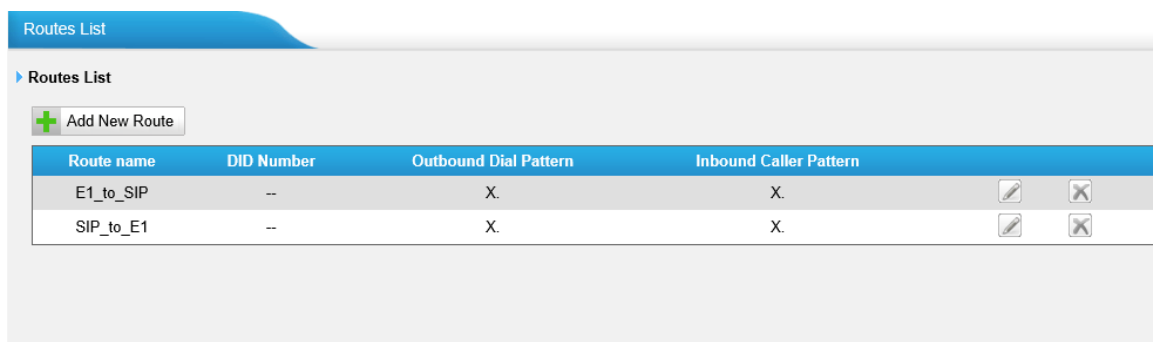

Routes List

Routes List

+ Add New Route

Route name	DID Number	Outbound Dial Pattern	Inbound Caller Pattern		
E1_to_SIP	--	X.	X.		
SIP_to_E1	--	X.	X.		

Figure 6-15

6.3.1 Route List

Click "edit" to check the details, there are two modes for you.

1) Simple mode

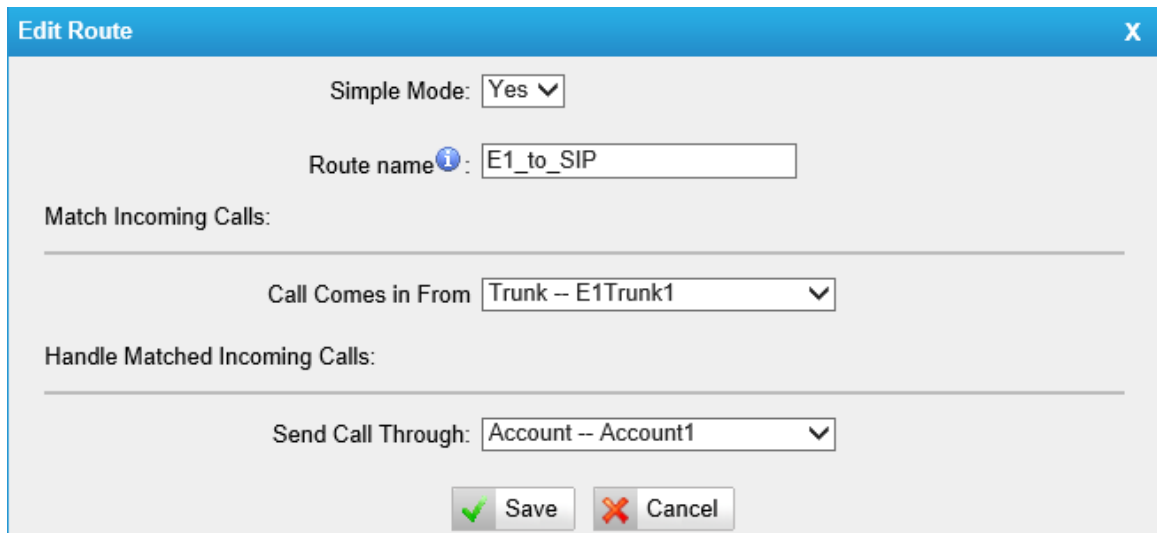

The screenshot shows the 'Edit Route' dialog box in Simple mode. The dialog has a blue header with the text 'Edit Route' and a close button (X). The main content area is light gray and contains the following fields and sections:

- Simple Mode:** A dropdown menu set to 'Yes'.
- Route name:** A text input field containing 'E1_to_SIP'.
- Match Incoming Calls:** A section header followed by a horizontal line.
- Call Comes in From:** A dropdown menu set to 'Trunk -- E1Trunk1'.
- Handle Matched Incoming Calls:** A section header followed by a horizontal line.
- Send Call Through:** A dropdown menu set to 'Account -- Account1'.
- Buttons:** At the bottom, there are two buttons: 'Save' (with a green checkmark icon) and 'Cancel' (with a red X icon).

Figure 6-16

Route name:

A name for this route.

Match incoming calls:

Choose the trunk or trunk group for the incoming calls

Handle matched incoming calls:

choose the trunk or trunk group to route the incoming calls to.

2) Detailed mode

Detailed mode can be accessed to by choosing "No" for "Simple mode".

Figure 6-17

Route name:

A name for this route.

Match incoming calls:

Choose the trunk or trunk group for the incoming calls.

Inbound caller pattern:

Match the prefix of caller ID for incoming calls.

X: Any Digit from 0-9

Z: Any Digit from 1-9

N: Any Digit from 2-9

[12345-9]: Any digit in the brackets (in this example, 1,2,3,4,5,6,7,8,9)

The "." Character will match any remaining digits. For example, "9011". will match any phone number that starts with "9011", excluding "9011" itself.

The "!" will match none remaining digits, and causes the matching process to complete as soon as it can be determined that no other matches are possible.

Example 1: **NXXXXXX** will match any 7-digit phone number.

Example 2: **1NXXNXXXXXX** will match a phone number starting with a 1, followed by a 3-digit area code, and then 6-digit number.

DID number:

Define the expected DID Number if this trunk passes DID on incoming calls. Leave this field blank to match calls with any or no DID info. You can also use pattern matching to match a range of numbers.

DID Associated Number:

Define the extension for DID number. This field is only valid when you use BRI, SIP, SPS or SPX trunk for this inbound router. You can only input number and '-' in this field, and the format can be xxx or xxx-xxx. The count of the number must be only one or equal the count of the DID number.

Handle matched incoming calls:

choose the trunk or trunk group to route the incoming calls to.

Outbound Dial Pattern

Outbound calls that match this dial pattern will use this outbound route. There are a number of dial pattern characters that have special meanings:

X: Any Digit from 0-9

Z: Any Digit from 1-9

N: Any Digit from 2-9

[12345-9]: Any digit in the brackets (in this example, 1, 2, 3, 4, 5, 6, 7, 8, 9)

The "." character will match any remaining digits. For example, "9011." will match any phone number that starts with "9011", excluding "9011" itself.

The "!" will match none remaining digits, and causes the matching process to complete as soon as it can be determined that no other matches are possible.

Example 1: **NXXXXXX** will match any 7-digit phone number.

Example 2: **1NXXNXXXXXX** will match a phone number starting with 1, followed by a 3-digit area code, and then 6-digit number.

Strip digits from front before dialing

Allows the user to specify the number of digits that will be stripped from the front of the phone number before the call is placed. For example, if users must press 0 before dialing a phone number, one digit should be stripped from the dial string before the call is placed.

Prepend these digits before dialing

These digits will be prepended to the phone number before the call is placed. For example, if a trunk requires 10-digit dialing, but users are more comfortable with 7-digit dialing, this field could be used to prepend a 3-digit area code to all 7-digit phone numbers before calls are placed.

6.3.2 Blocklist

Blocklist is used to block an incoming/outgoing call. If the number of incoming/outgoing call is listed in the number Blocklist, the caller will hear the following prompt: "The number you have dialed is not in service. Please check the number and try again". The system will then disconnect the call.

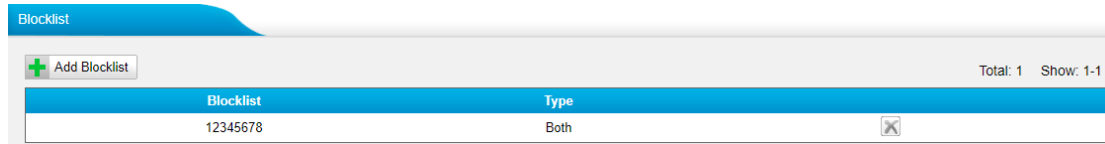

Figure 6-18

We can add a number with the type: inbound, outbound or both

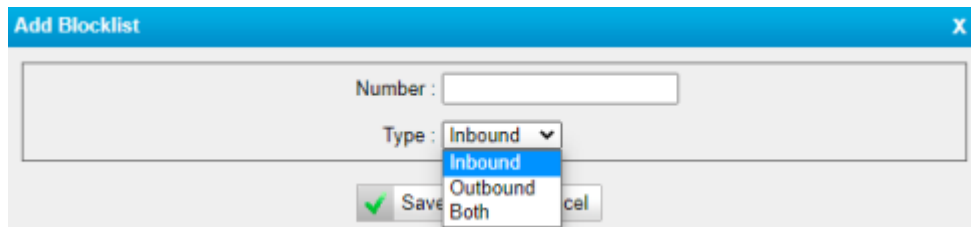



Figure 6-19

7. Logout



Click  to log out safely to the log in page.

8. Application

Application 1

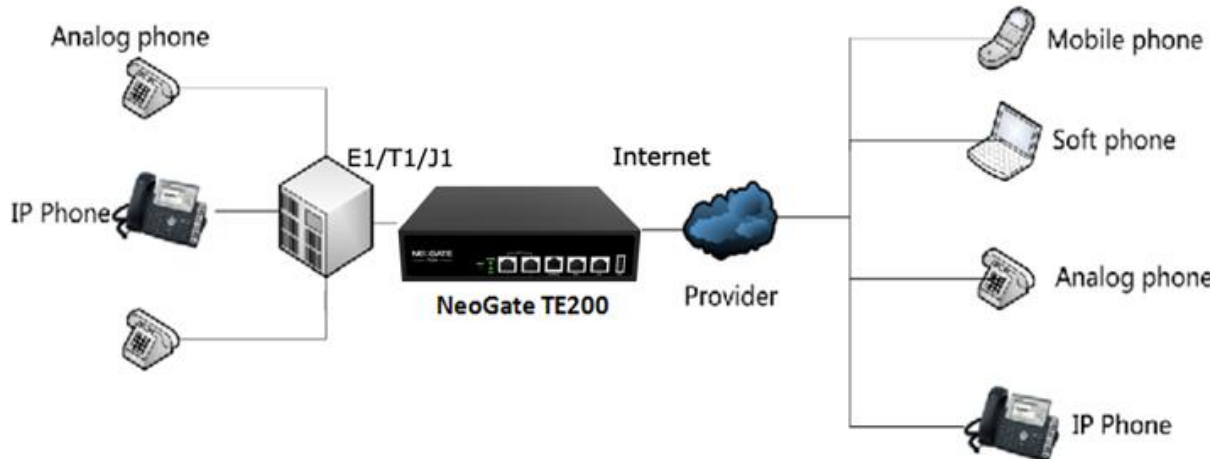

Figure 8-1

Application 2

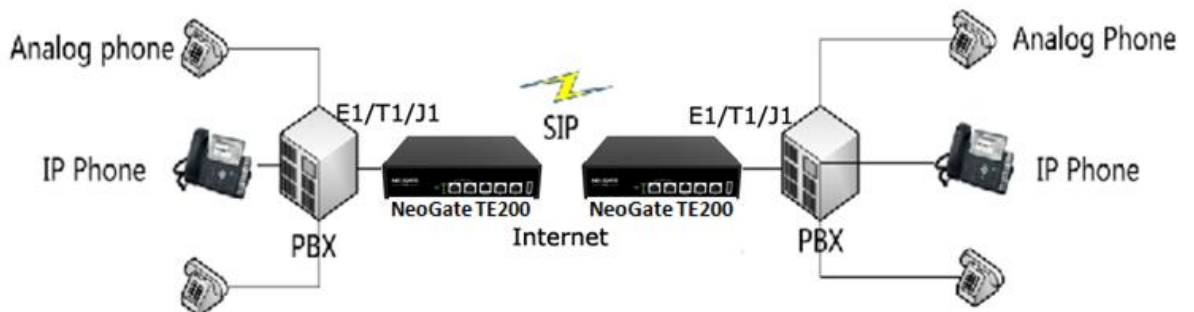

Figure 8-2

<Finish>

